

MATLAB EXPO 2018

What's Behind 5G Wireless Communications?

Graham Freeland



Agenda

- » 5G goals and requirements
- » Modeling and simulating key 5G technologies
 - Release 15: Enhanced Mobile Broadband
 - IoT and V2X
- » 5G development workflow

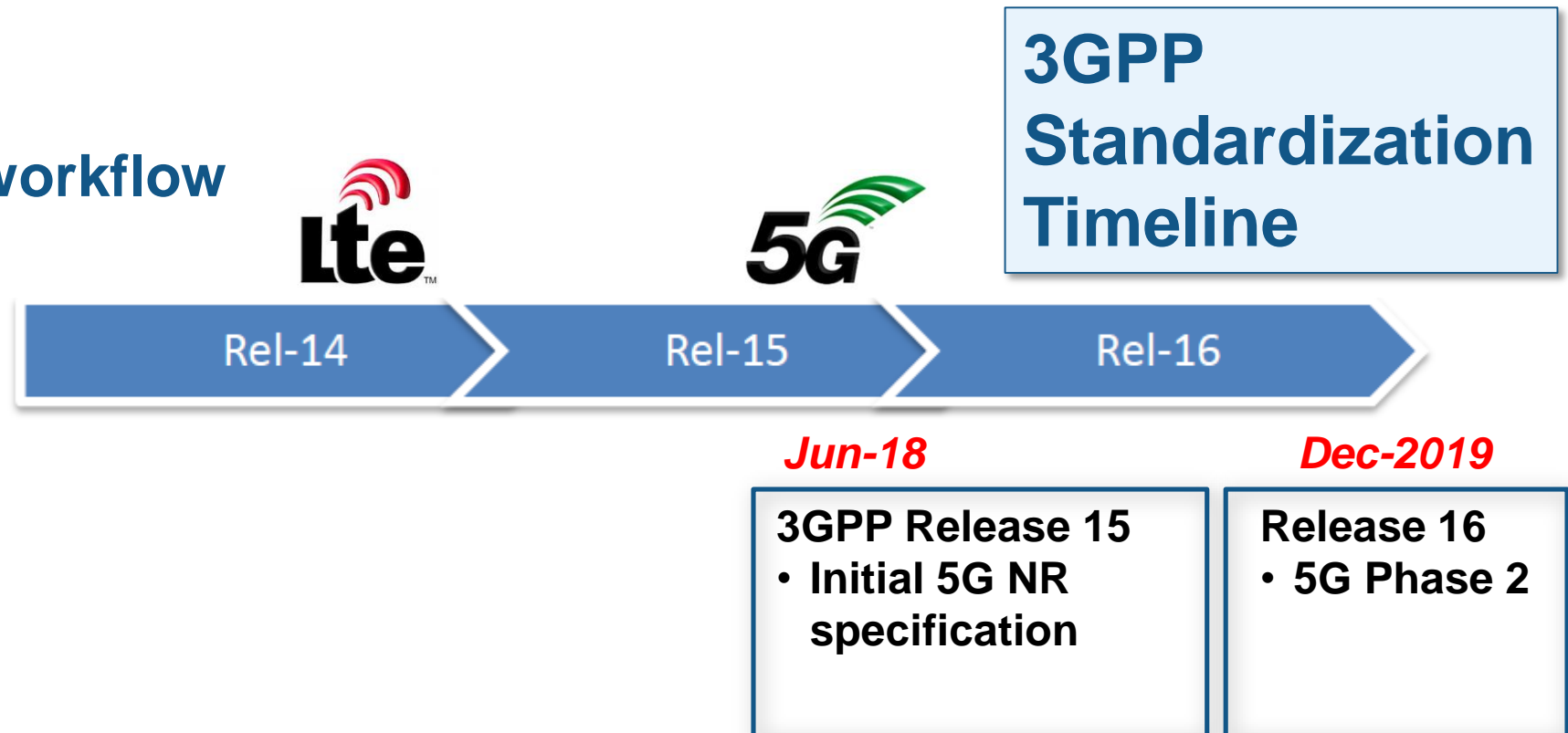

5G Applications and Requirements

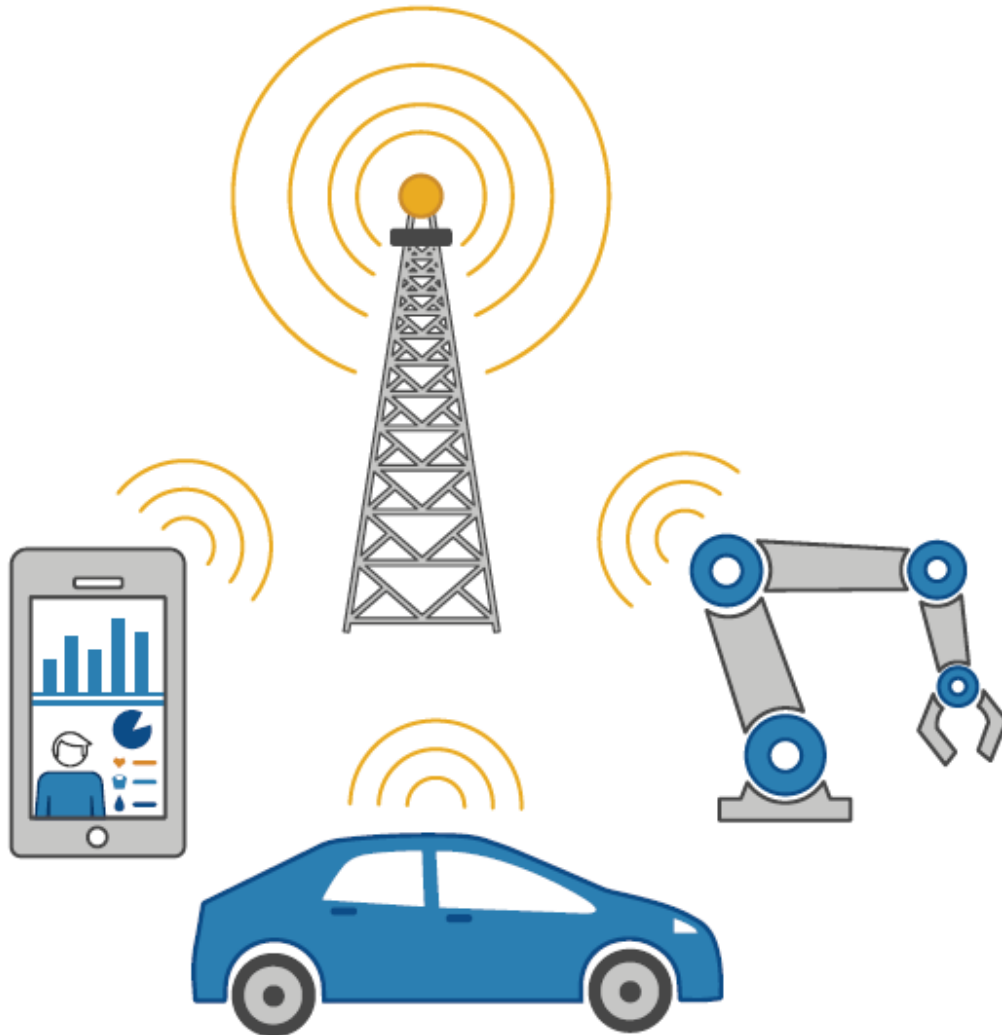

New Applications

4K, 8K, 360° Video
Virtual Reality
Connected Vehicles
Internet of Things



5G Requirements / Use Cases

Enhanced mobile broadband (>10 Gbps)
Ultra low latency (<1 ms)
Massive machine-type communication (>1e5 devices)

Achieving Higher 5G Broadband Data Rates

Technical Solutions

Increased bandwidth
 Better spectral efficiency
 Flexible air interface
 Densification



Higher Frequency Bands

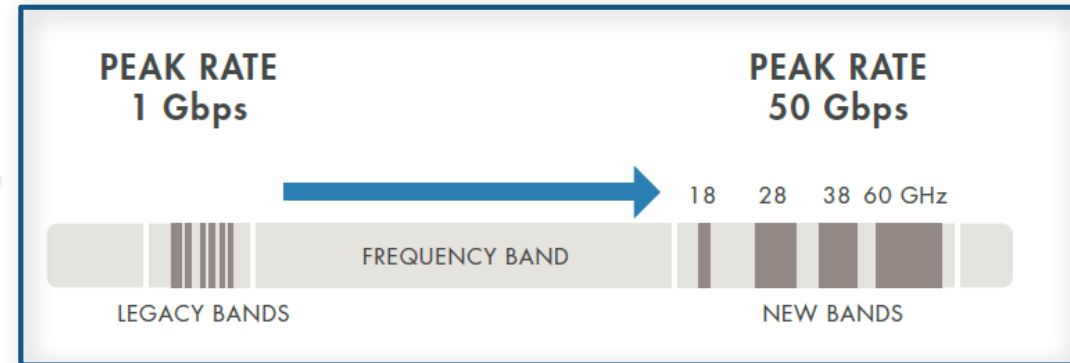

New Physical Layer

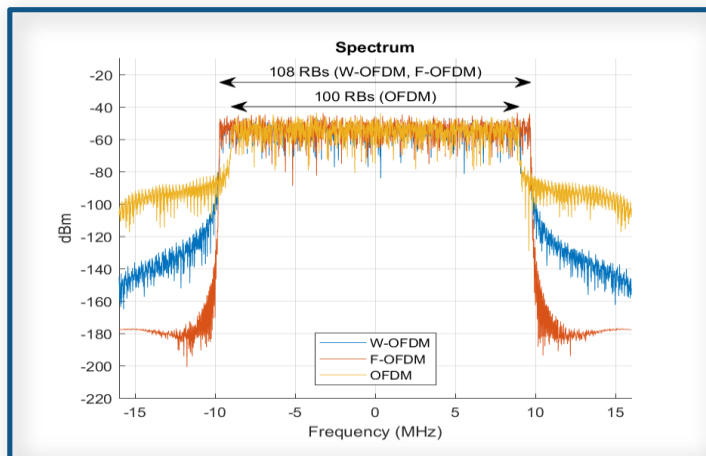

New RF Architectures

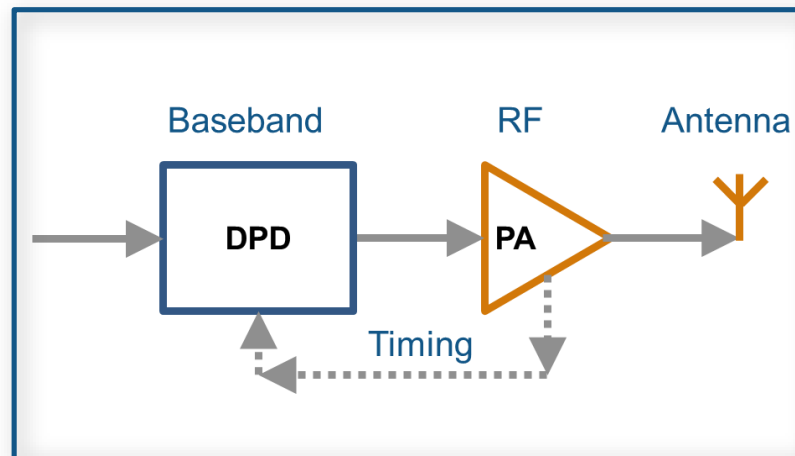

Massive MIMO



Massive MIMO antenna array for a Huawei 5G field trial.

Multi-Domain Engineering for 5G

Subsystems must be designed and tested together

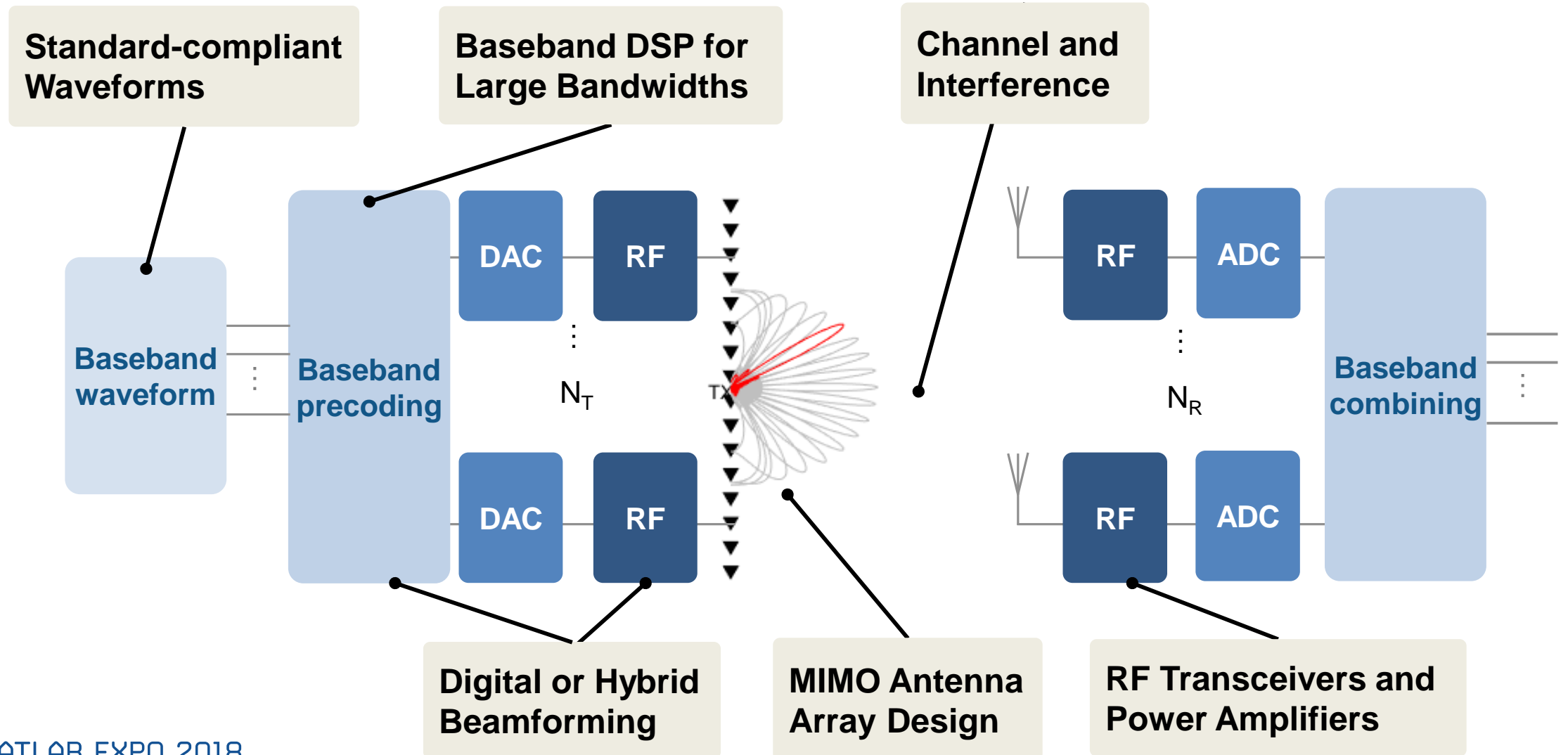

Agenda

- **5G goals and requirements**
- **Modeling and simulating key 5G technologies**
 - Release 15: Enhanced Mobile Broadband
 - IoT and V2X
- **5G development workflow**

Waveform Generation

- Test with standard-compliant waveforms
- Generate all physical channels and signals
- Off-the-shelf and full custom waveforms

5G

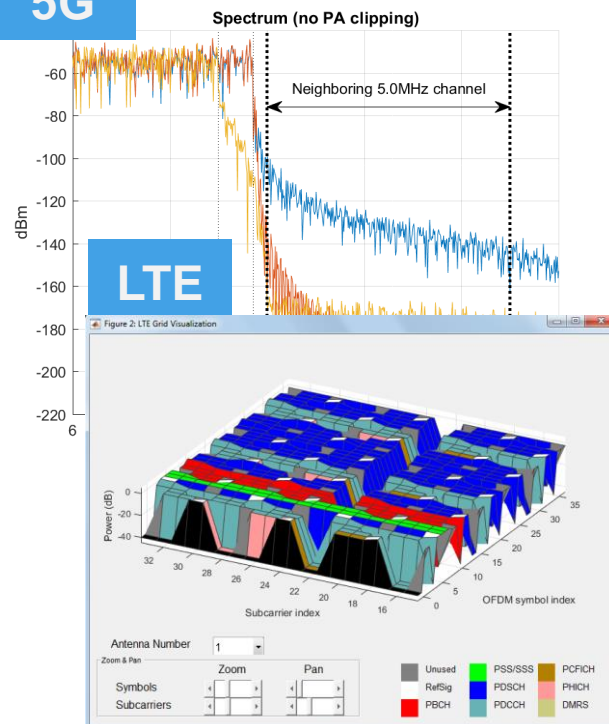

3GPP

- ✓ LTE & LTE-Advanced
- ✓ NB-IoT
- ✓ D2D Sidelink
- ✓ V2X Sidelink
- ✓ **5G New Radio**

R2018b

Standard compliance

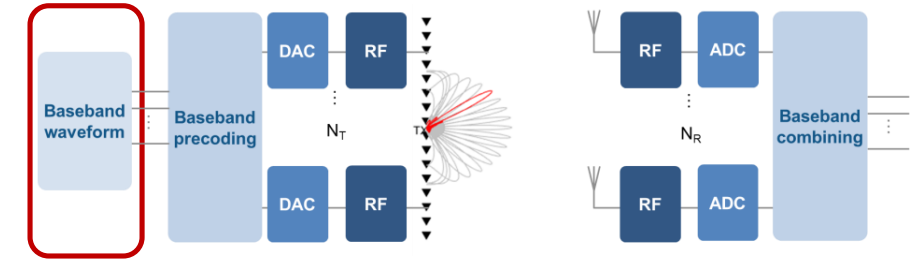

WLAN

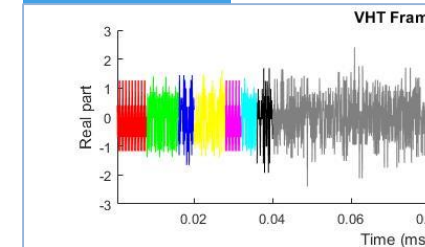

IEEE 802.11

✓ **802.11ax (draft)**

✓ 802.11ad **R2018b**

✓ 802.11ah

✓ 802.11ac

✓ 802.11a/b/g/n

✓ 802.11p/j

New Physical Layer in Release 15

- Enhanced Mobile Broadband (eMBB):
 - Larger bandwidth
 - Greater spectral efficiency
- PHY techniques used to achieve goals
 - Flexible frame structure and carrier spacing
 - Shorter slot durations for lower latency
 - Variable bandwidth
 - Higher capacity coding schemes
 - Spatial channel models: sub-6GHz to mmWave

5G Baseband Processing

- Increased bandwidth
- Greater spectral efficiency

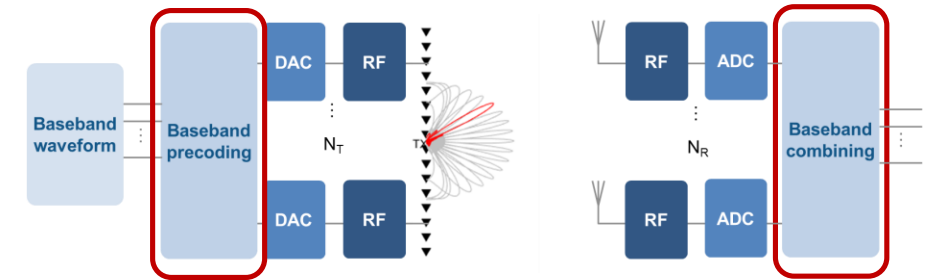

Baseband DSP for Large Bandwidths

- 5G waveform same as LTE: Cyclic-Prefix OFDM (CP-OFDM)
- Flexible NR subcarrier spacing and frame numerologies

5G Toolbox

NEW PRODUCT

R2018b

μ	Subcarrier Spacing $\Delta f = 2^\mu * 15\text{kHz}$	Bandwidth (MHz)
0	15	49.50
1	30	99
2	60	198
3	120	396
4	240	397.44
5	480	397.44

Flexible bandwidth
latency in 5G NR

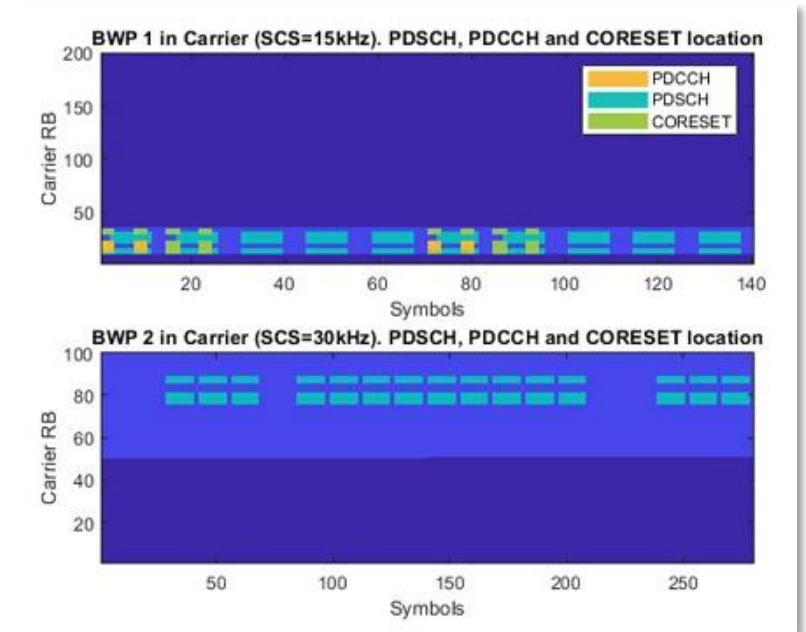

Downlink waveform generation
with carrier bandwidth parts

Efficient Channel Coding Methods

- Low-Density Parity Check (LDPC) for data channel: memoryless block coding

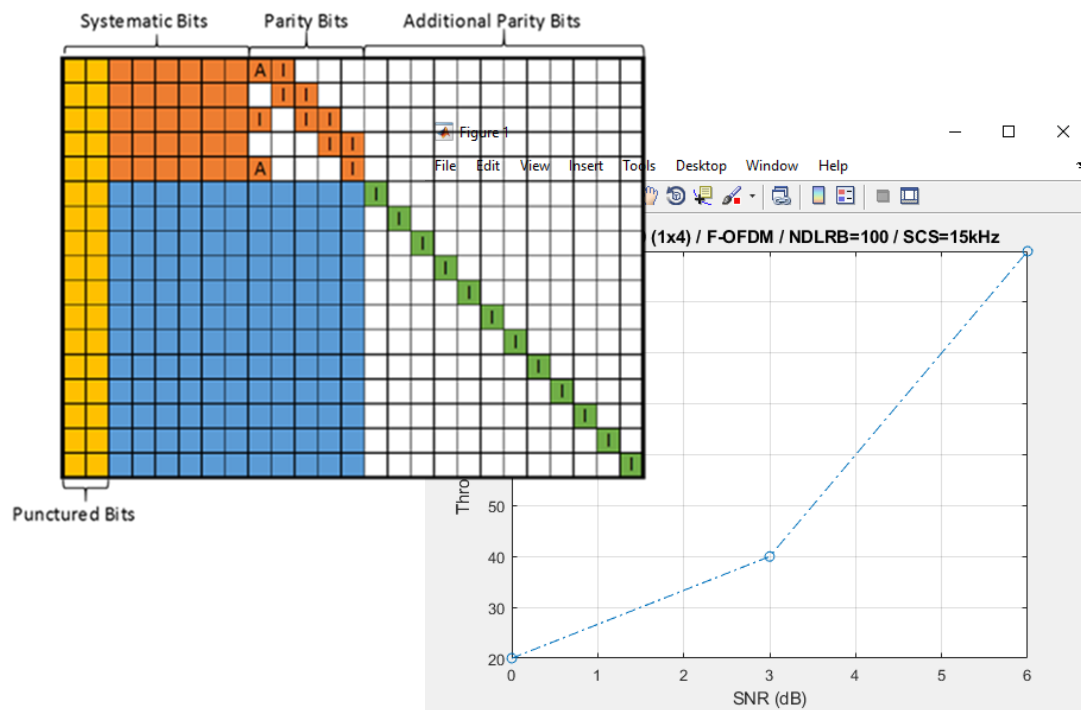

MATLAB EXPO 2018

- Polar Codes for control channel: achieve channel capacity

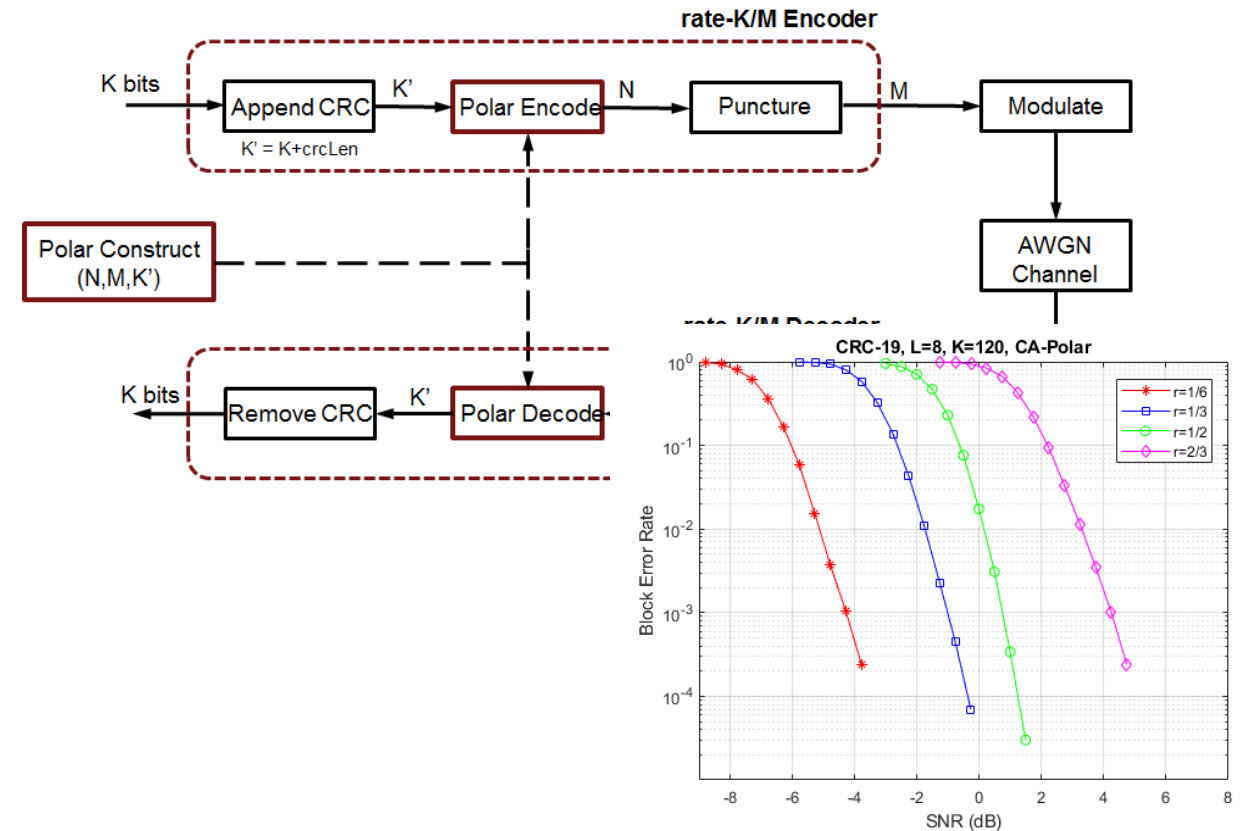

Model Channel and Interference

- Interference
 - Multiple standards: 5G/LTE/WLAN

- 3D propagation channels
 - 5G, LTE, 802.11, Custom

- Visualize propagation on maps
 - Rx/Tx location
 - Signal strength and coverage
 - Signal-to-interference-plus-noise (SINR)

Channel and Interference

- Multiple UEs/Base Stations
- Signal propagation

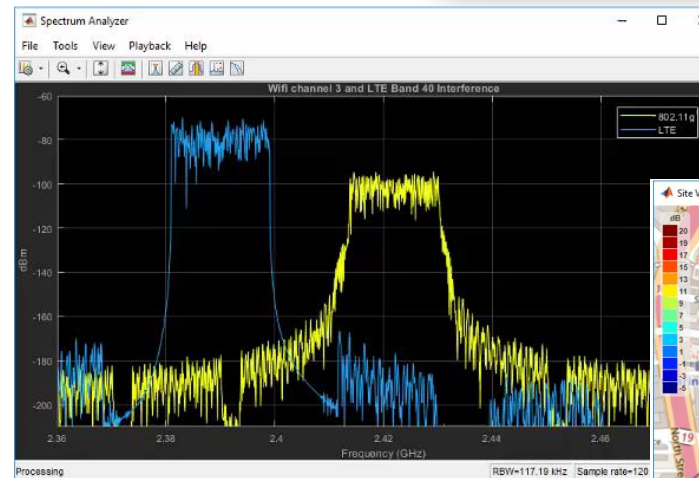
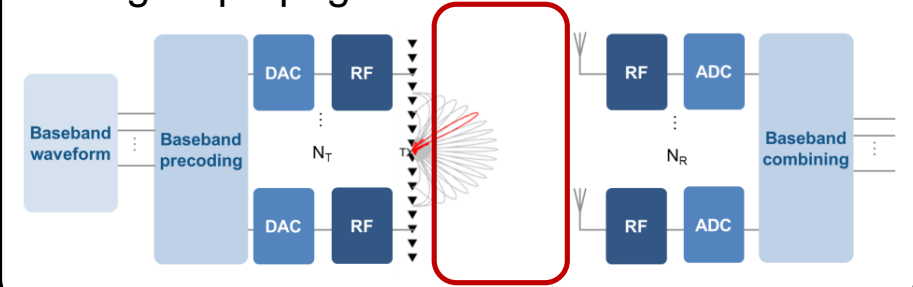

LTE-WLAN interference

R2018a

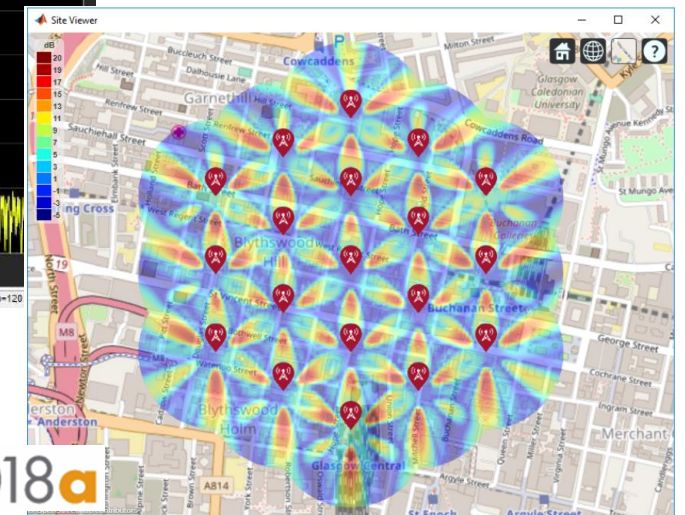

SINR for 5G urban macro-cell

5G Channel Model

- 3GPP TR 38.901: 500 MHz - 100 GHz (mmWave)
- For massive MIMO arrays (>1024 elements)
- Delay profiles:
 - Clustered delay line (CDL): Full 3D model
 - Tapped delay line (TDL): Simplified for faster simulation
- Control key parameters
 - Channel delay spread
 - Doppler shift
 - MIMO correlation

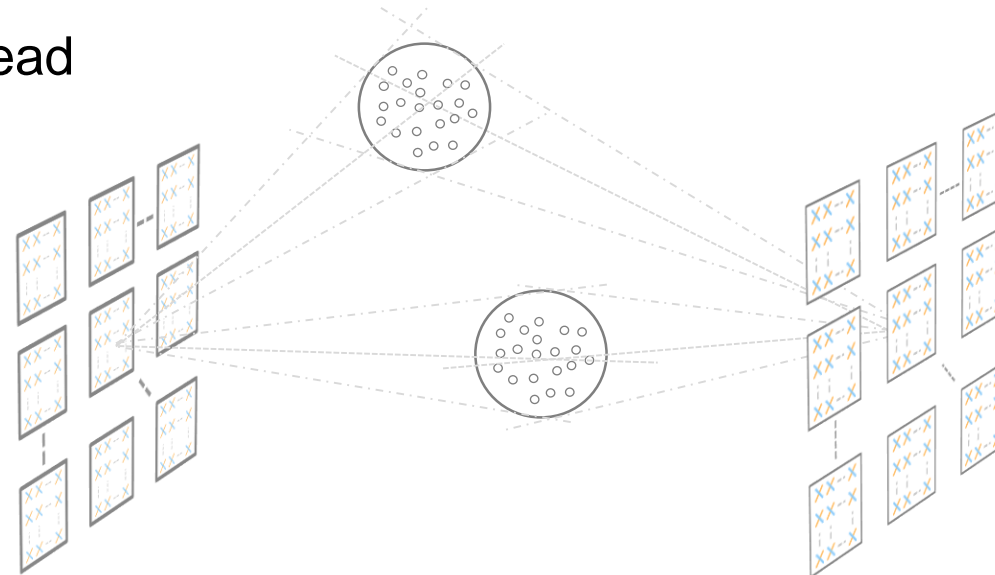

Cluster Delay Line: 3D model

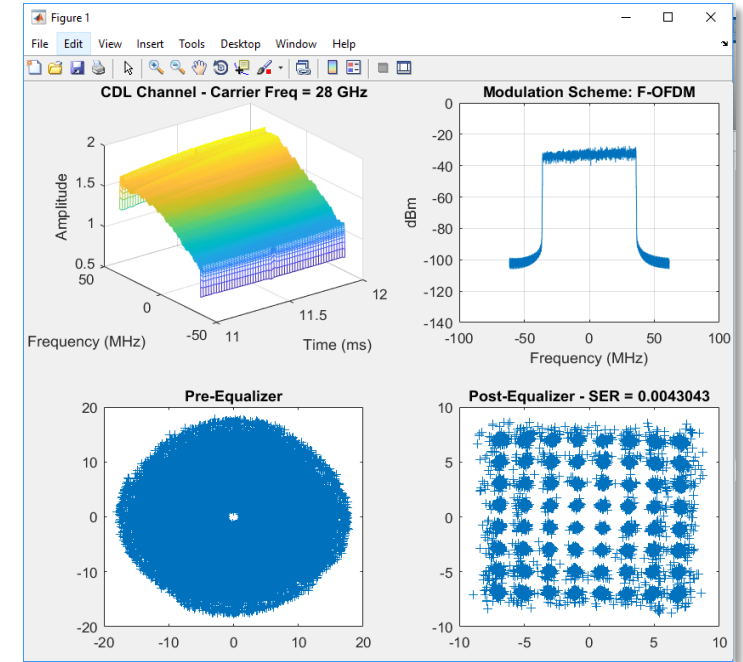

5G Link Level Simulation

- End-to-end physical layer reference model
- Verify implementation
- Evaluate impact of algorithm designs on link performance

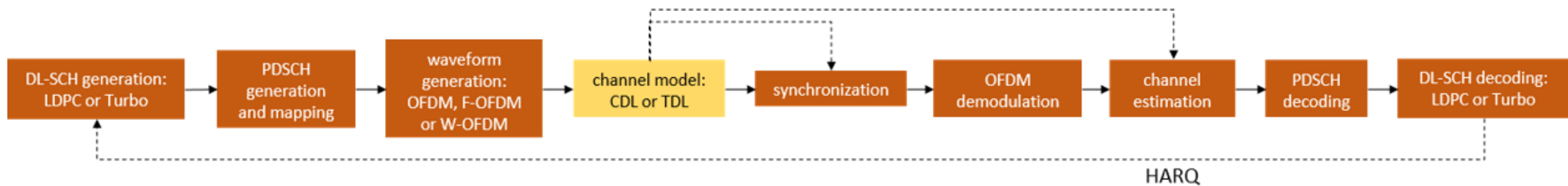
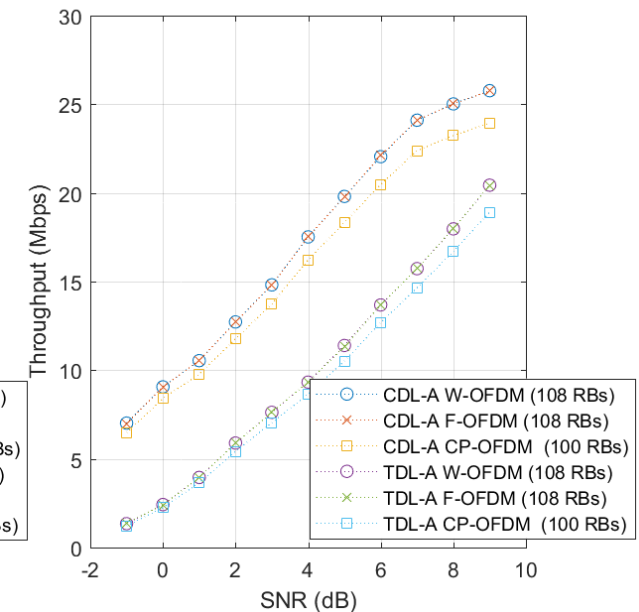
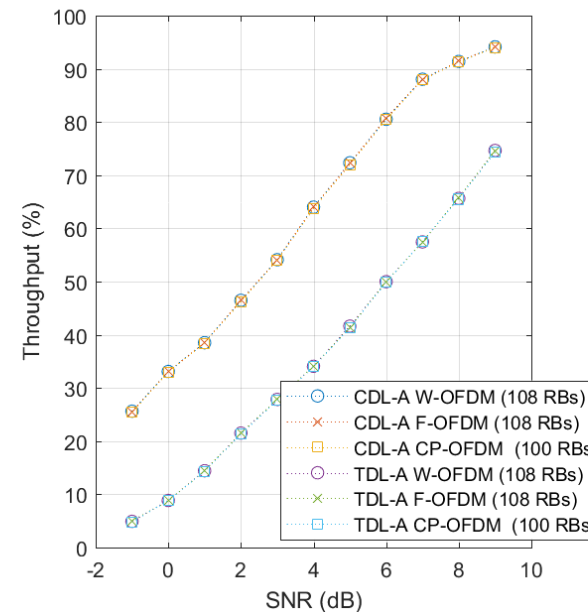

RF Power Amplifier (PA) Linearization

- 5G frequencies and bandwidth put greater requirements on RF transmitter efficiency

- 5G PA's are difficult to model
 - Non-linearity
 - Memory effects
- Solution: Linearization using adaptive digital pre-distortion (DPD)

RF challenges in 5G

- Frequency dependent behavior
- Highly integrated RF + digital devices

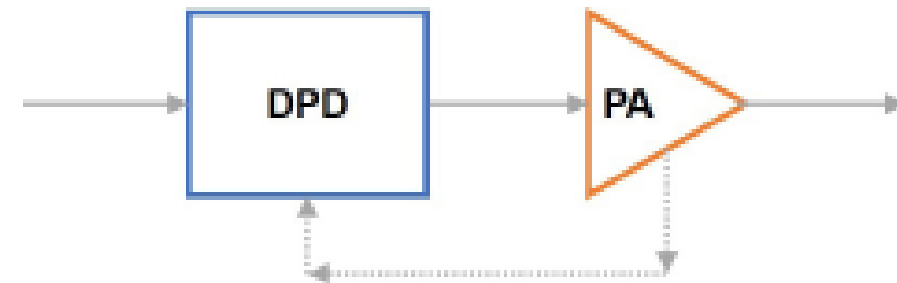
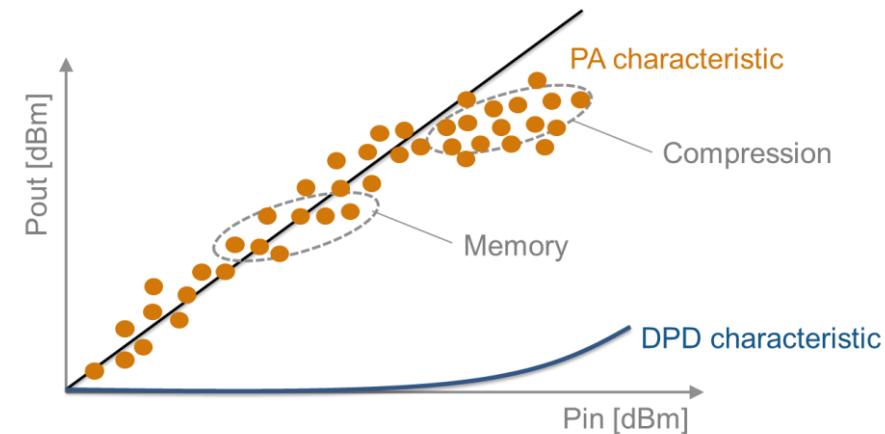
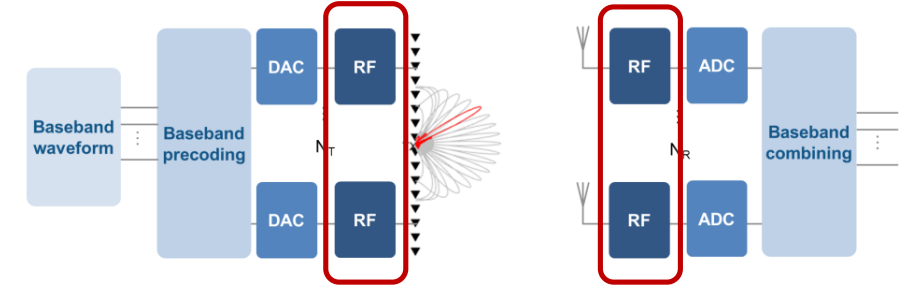

Characterize PA Model Using Measured Data

PA Data

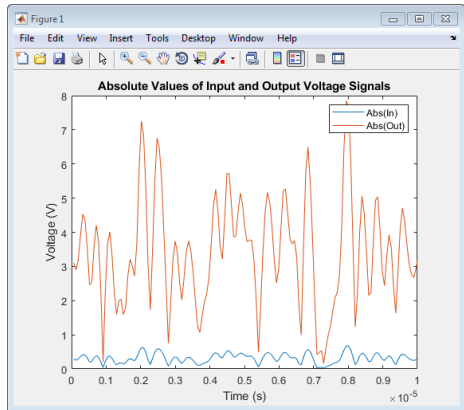

MATLAB fitting procedure
(White box)

```
function a_coef = fit_memory_poly_model(x,y,memLen,degLen,modType)
% FIT_MEMORY_POLY_MODEL
% Procedure to compute a coefficient matrix given input and output
% signals, memory length, nonlinearity degree, and model type.
%
% Copyright 2017 Mathworks, Inc.

x = x(:);
y = y(:);
xLen = length(x);

switch modType
case 'memPoly' % Memory polynomial
    xrow = reshape((memLen:-1:1) + (0:xLen:xLen*(degLen-1)),1,[]);
    xVec = (0:xLen-memLen)' + xrow;
    xPow = x.*(abs(x).^(0:degLen-1));
    xVec = xPow(xVec);
case 'ctMemPoly' % Cross-term memory polynomial
    absPow = (abs(x).^(1:degLen-1));
    partTop1 = reshape((memLen:-1:1)'+(0:xLen:xLen*(degLen-2)),1,[]);
    topPlane = reshape(
        [ones(xLen-memLen+1,1),absPow((0:xLen-memLen)' + partTop1)].', ...
        1,memLen*(degLen-1)+1,xLen-memLen+1);
    sidePlane = reshape(x((0:xLen-memLen)' + (memLen:-1:1)).', ...
        memLen,1,xLen-memLen+1);
    cube = sidePlane.*topPlane;
    xVec = reshape(cube,memLen*(memLen*(degLen-1)+1),xLen-memLen+1).';
end

coef = xVec\y(memLen:xLen);
a_coef = reshape(coef,memLen,numel(coef)/memLen);
```

R2018a

MATLAB PA model

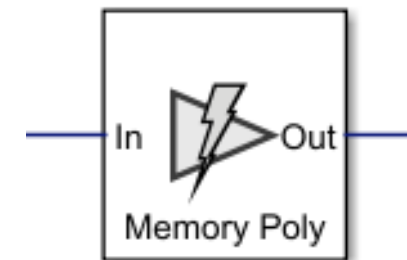
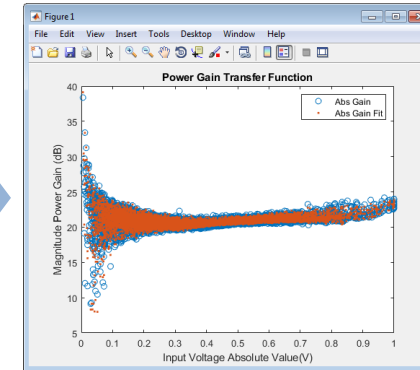

PA model for circuit
envelope simulation

PA + DPD Simulation

- Closed loop multi-domain simulation
 - Circuit Envelope for fast RF simulation
 - Low-power RF and analog components
 - DPD signal processing algorithm (behavioral or hardware-accurate)

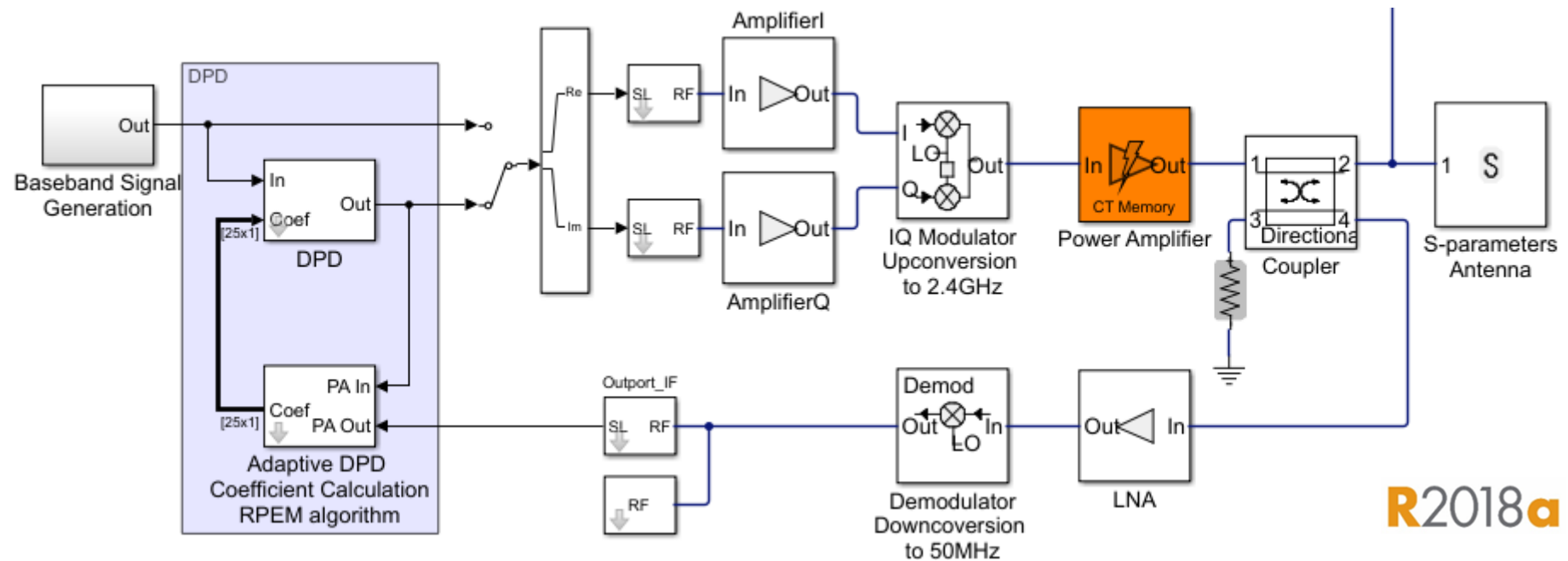
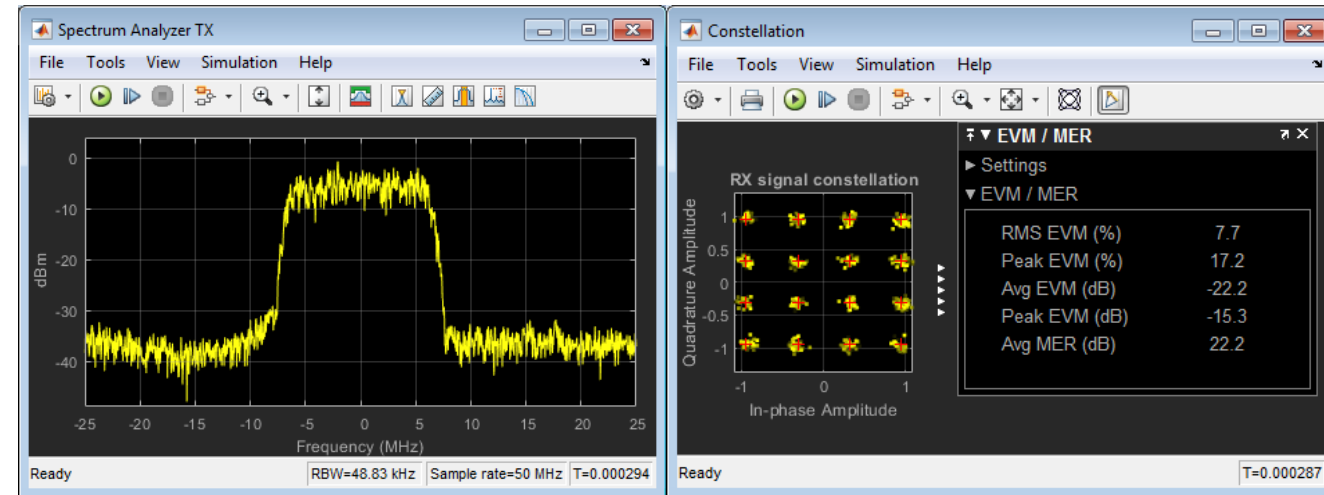

R2018a

Massive MIMO Antenna Arrays

- Model antenna and array beam patterns
- Model antenna element failures
- Optimize tradeoffs between antenna gain and channel capacity
- Simulate with 3D channel model

Antenna array design considerations

- Element coupling
- Imperfections

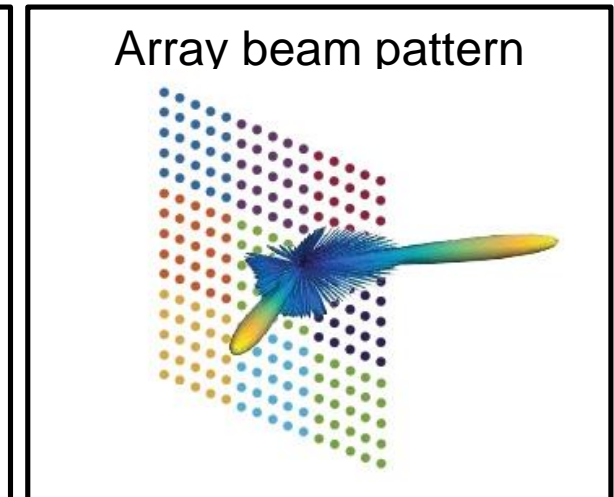
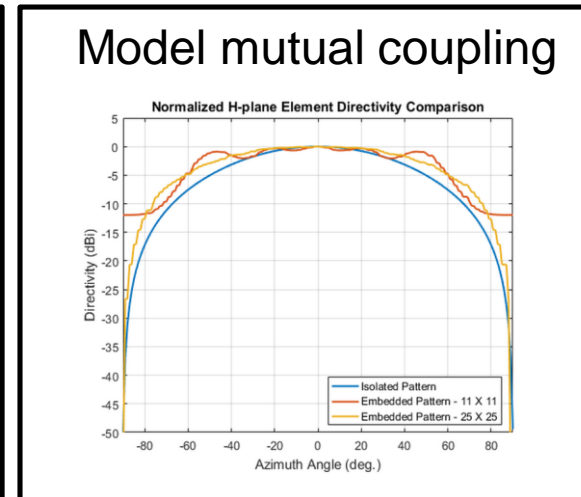
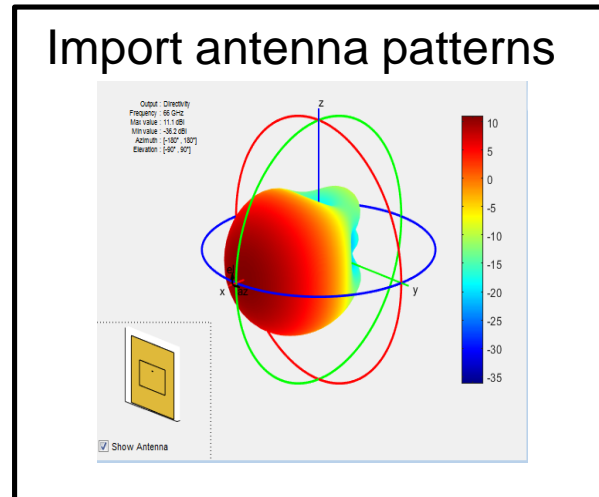
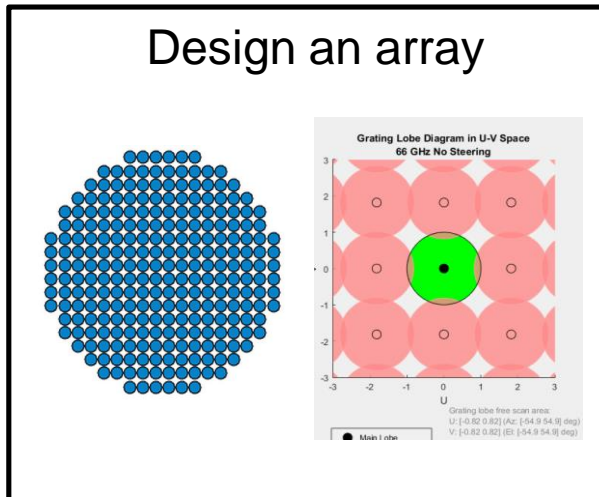
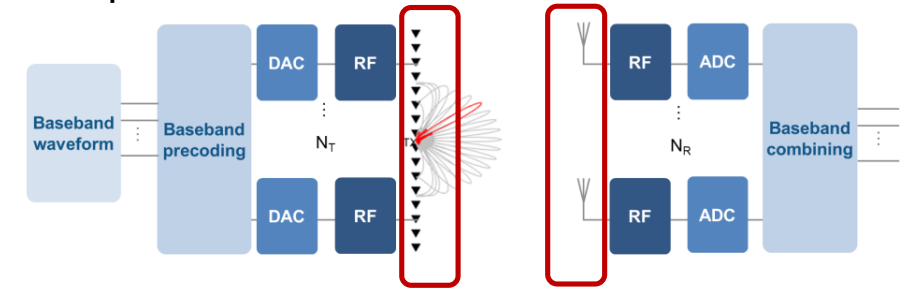

Hybrid Beamforming for Massive MIMO

- Beamforming partitioned between digital and RF
 - Each Tx and Rx element has phase control
 - Subarrays handle amplitude and additional phase
 - Number of transmit antennas can be $\gg N_S$ (N_{RF})
- Model and optimize beamforming architecture
- Model imperfections in the signal chain

Why Hybrid Beamforming?

- Massive MIMO reduces mmWave propagation loss
- Hybrid beamforming reduces implementation cost

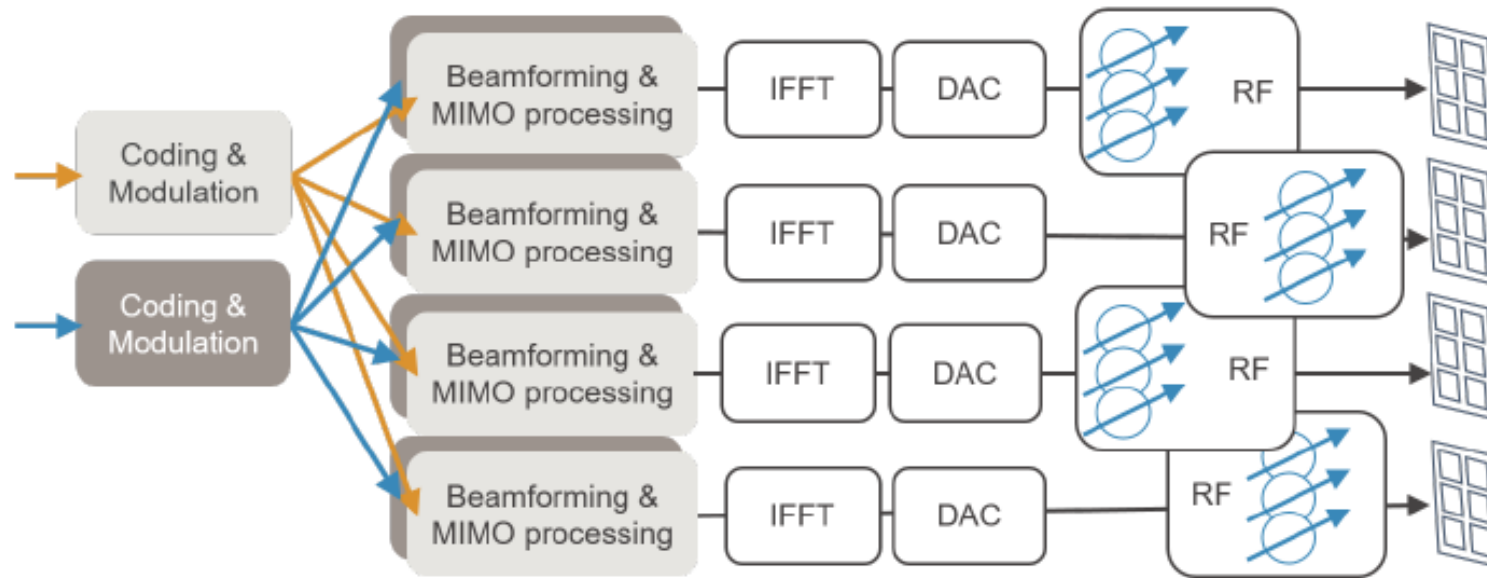
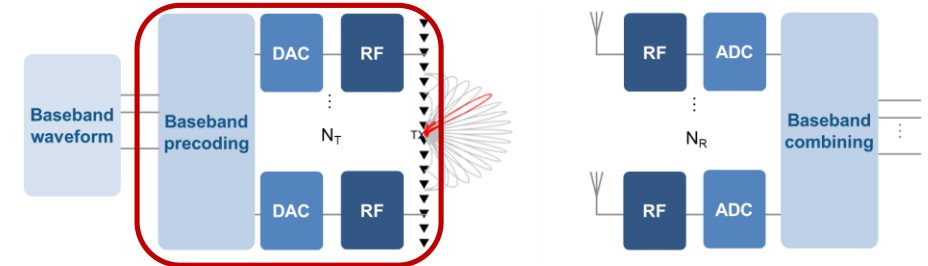

Agenda

- **5G goals and requirements**
- **Modeling and simulating key 5G technologies**
 - Release 15: Enhanced Mobile Broadband
 - Connecting Vehicles and IoT Devices
- **5G development workflow**



V2X: Building the Connected Car Highway

Standards for V2X

- 5G: Reserved for future release
- Cellular V2X (C-V2X)
 - Release 14 LTE Sidelink
 - **LTE Toolbox**
- DSRC
 - IEEE 802.11p
 - **WLAN Toolbox**

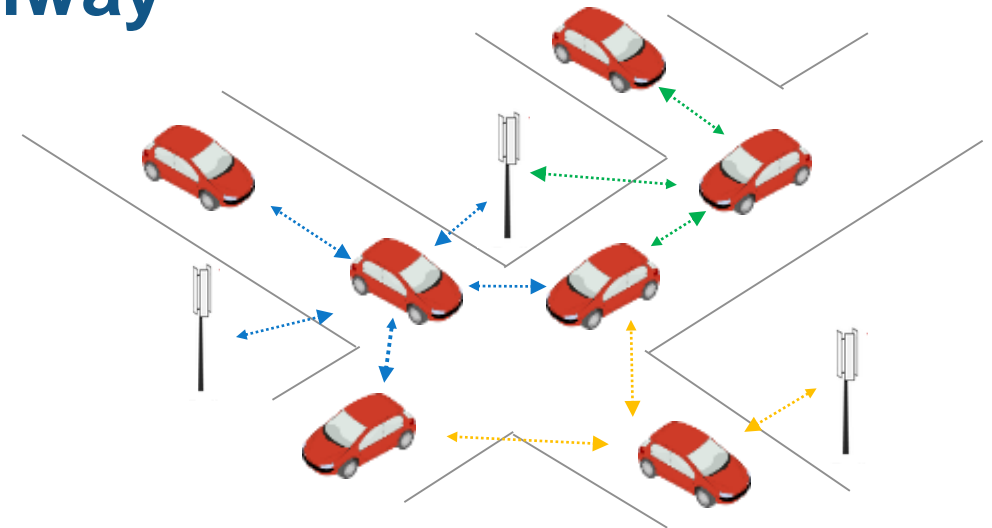

PHY Waveform Generation

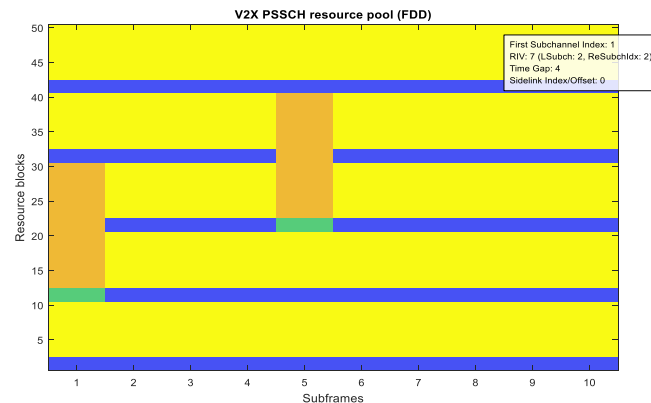

Throughput Simulation

R2017b

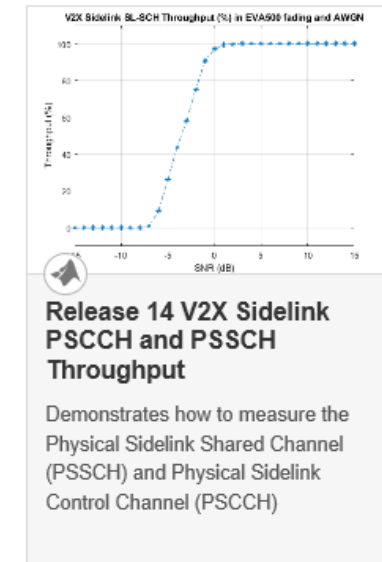

Future 5G Use Case: IoT Connectivity

- IoT use case reserved for future 5G release
- Cellular long-range standard: LTE NB-IoT
 - Compatible with LTE networks
 - Lower cost and power, extended range
- NB-IoT cost and power reduction techniques
 - Reduced peak rate and bandwidth (180 kHz)
 - Reduced maximum transmit power
 - Single antenna
 - No higher-order modulation (BPSK and QPSK)

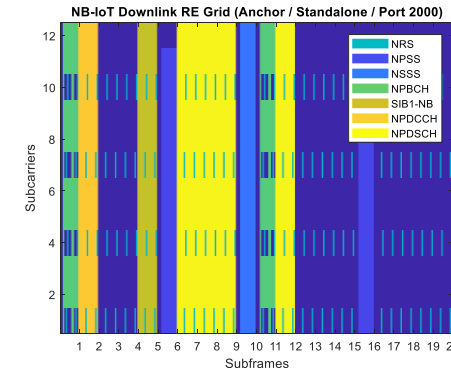

Waveform Generation

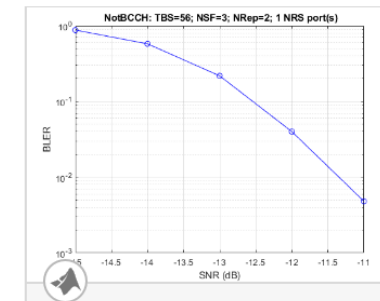
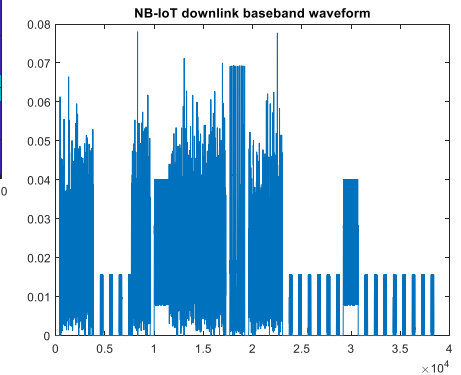

NB-IoT NPDSCH Block Error Rate Simulation

How LTE System Toolbox™ can be used to create a NB-IoT Narrowband Physical Downlink Shared Channel (NPDSCH) Block

R2018a

BLER Simulation

Agenda

- 5G goals and requirements
- Modeling and simulating key 5G technologies
 - Release 15: Enhanced Mobile Broadband
 - Connecting Vehicles and IoT Devices
- » ▪ 5G development workflow



From idea ...

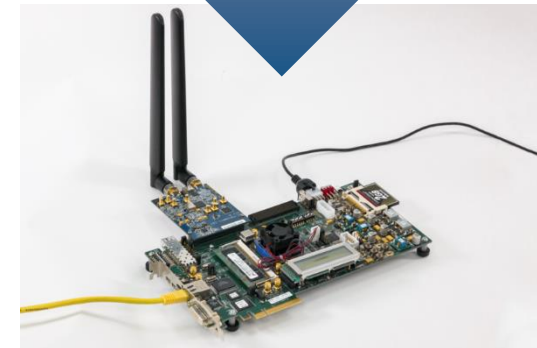
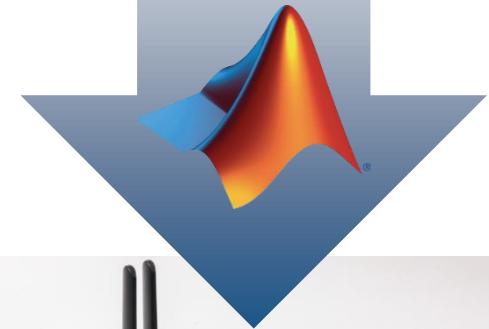

... to implementation

Customer Perspective

“We need a multidomain platform for simulation, rapid prototyping, and iterative verification from the behavior model to testbed prototyping to the industrial product. MATLAB and Simulink are helping us to achieve these goals.”

- Kevin Law, director of algorithm architecture and design, Huawei

Can you tell us more about how MATLAB and Simulink are helping you?

These two platforms play an important role in our innovation areas like 5G, optical communication, and wireless terminals. The tools give us top-down Model-Based Design, a product ecosystem that covers multiple domains, and code generation and iterative verification.

https://www.mathworks.com/content/dam/mathworks/tag-team/Objects/h/80861v00_Huawei_QA.pdf

MATLAB & Simulink Wireless Design Environment

for baseband, RF, and antenna modeling and simulation

Algorithms, Waveforms, Measurements

- Communications Toolbox
- 5G Toolbox
- LTE Toolbox
- WLAN System Toolbox

RF Front End

- RF Toolbox
- RF Blockset

Antennas, Beamforming

- Antenna Toolbox
- Phased Array System Toolbox

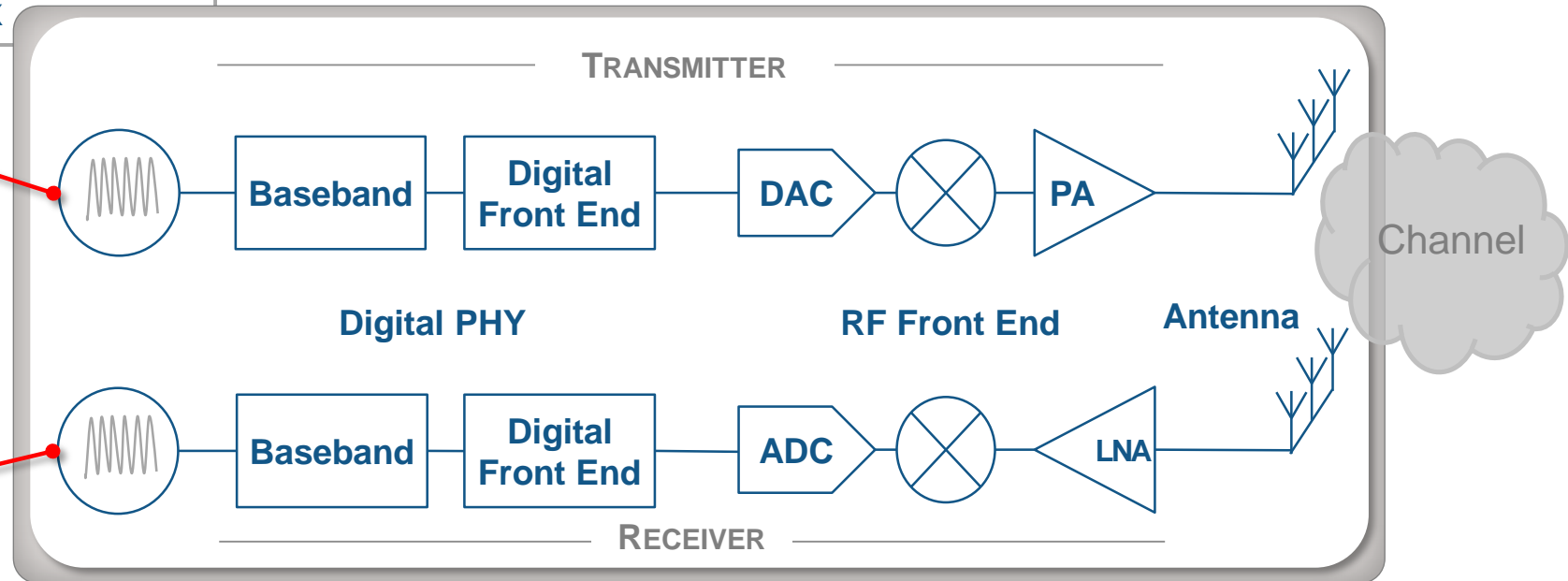
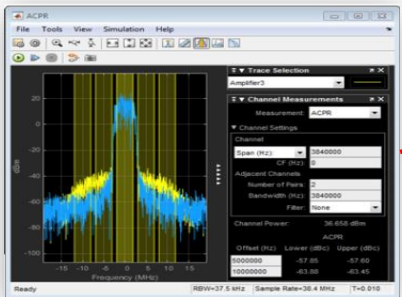
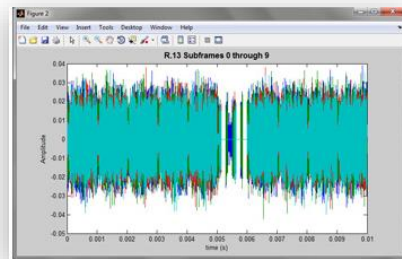

- Simulink
- DSP System Toolbox
- Control System Toolbox

Mixed-signal

- Communications Toolbox
- Antenna Toolbox
- 5G, LTE, WLAN Toolboxes

Channel and Propagation

Over-the-Air Testing with SDR and RF Instruments

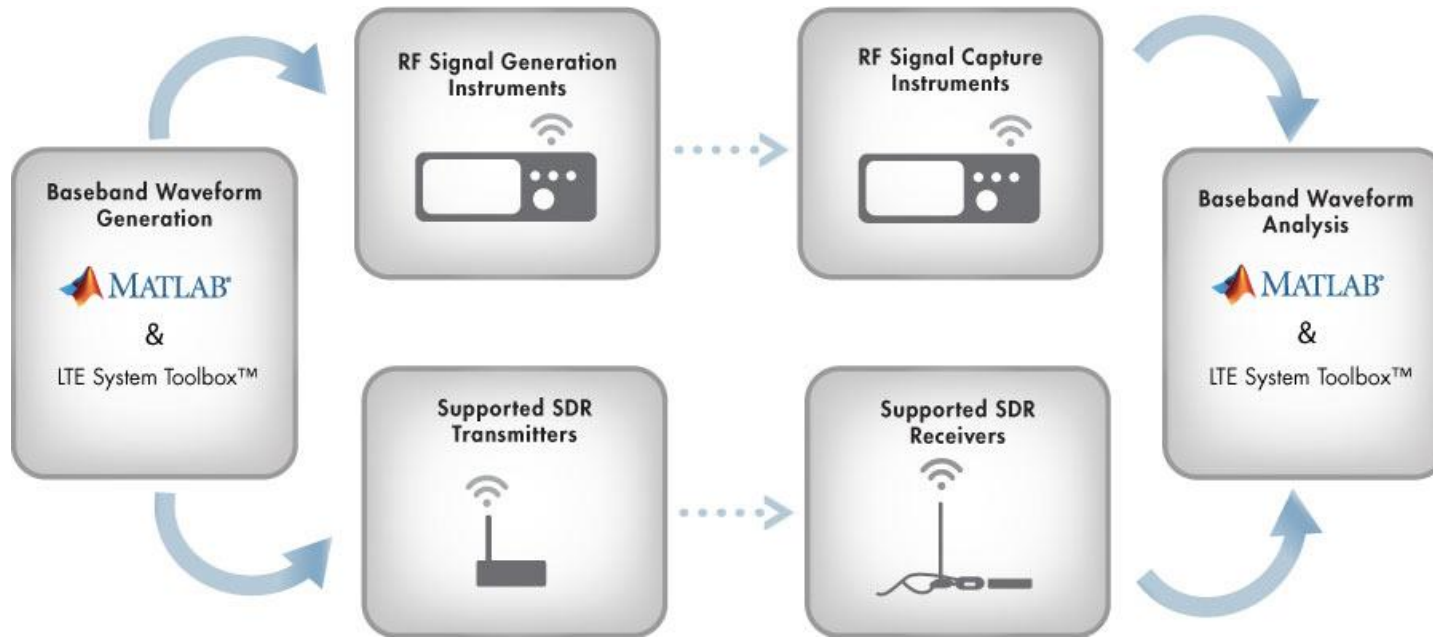

Over-the-air Testing
 Instrument Control Toolbox
 SDR Support Packages
Communications Toolbox



Accelerate Simulations with Scalable Computing

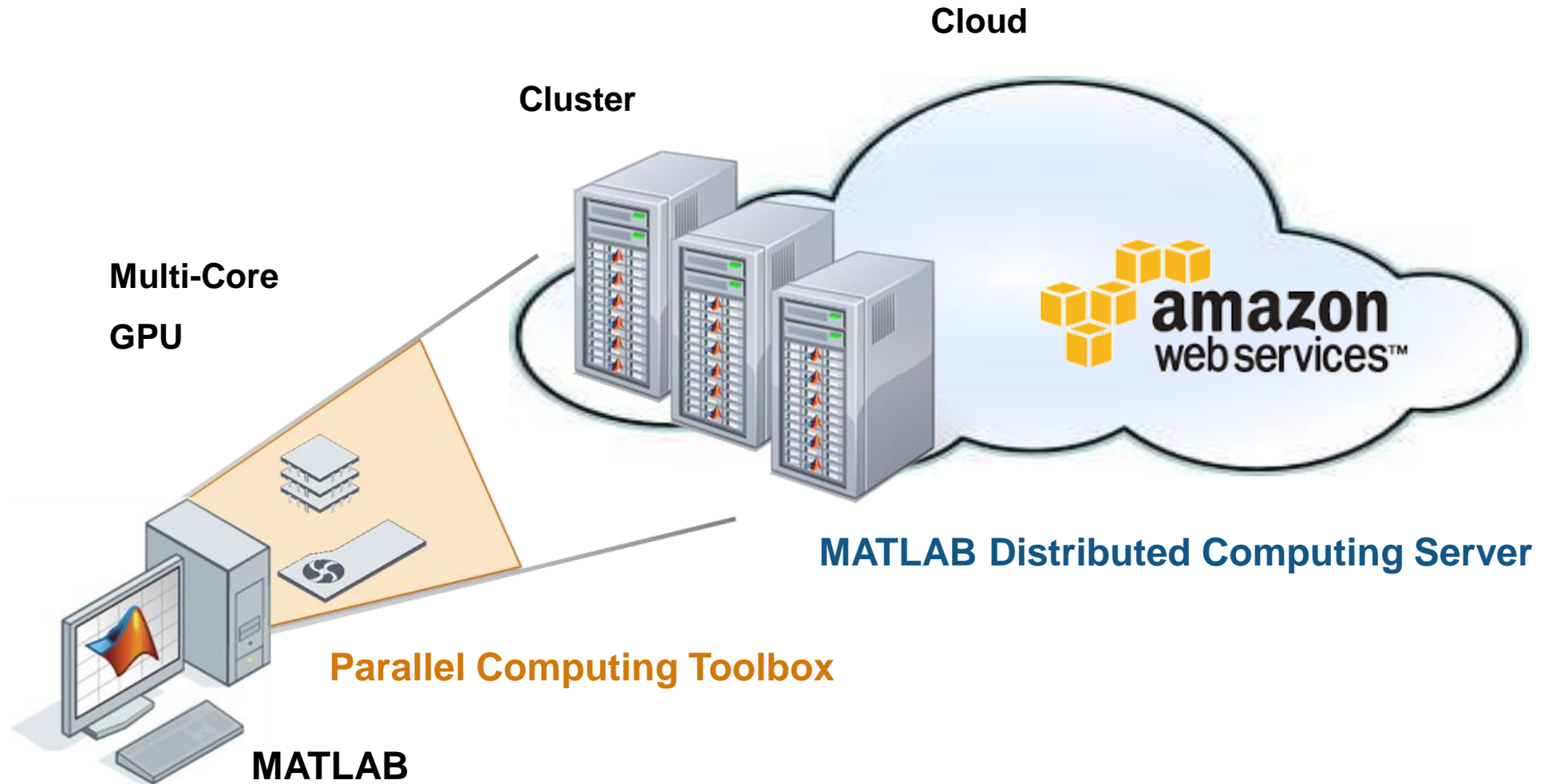

Common Platform for Wireless Development

MATLAB® & SIMULINK®

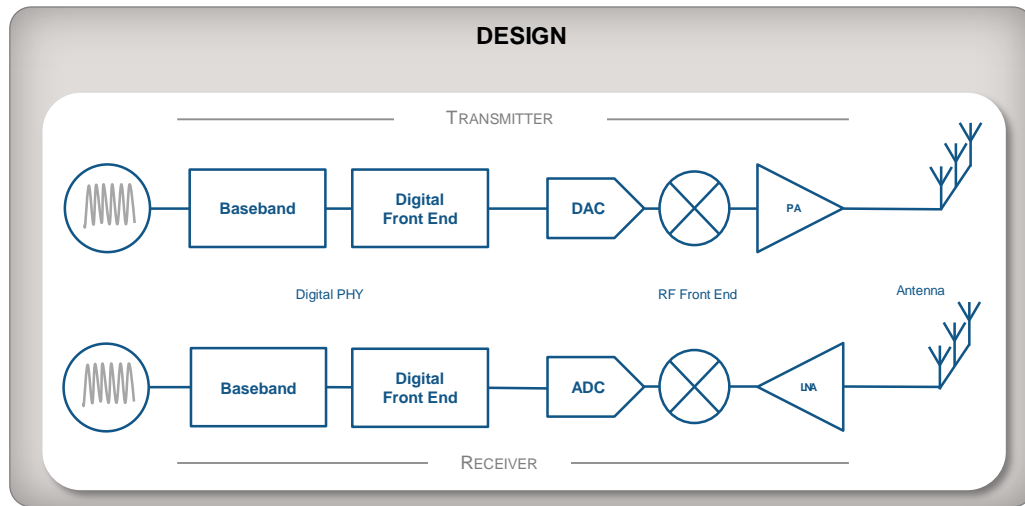

- Algorithm Design and Verification
- RF, Digital and Antenna Co-Design
- System Verification and Testing
- Rapid Prototyping and Production

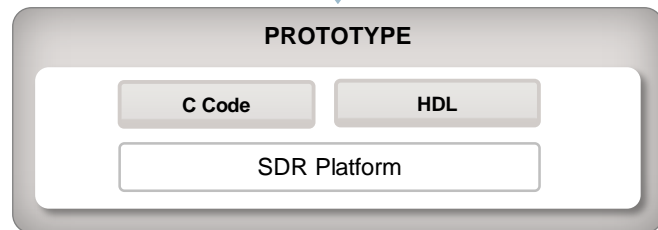

Code Generation and Verification
 Fixed-Point Designer
 HDL Coder
 HDL Verifier
 LTE HDL Toolbox **R2017b**
 Embedded Coder

Agenda

- **5G goals and requirements**
- **Modeling and simulating key 5G technologies**
 - Release 15: Enhanced Mobile Broadband
 - Connecting Vehicles and IoT Devices
- **5G development workflow**
- » ▪ **Learn more...**

Resources to Help You Get Started – Links in PDF Document

Downlink Carrier Waveform Generation

Implements a 5G NR downlink carrier waveform generator using 5G Toolbox™.

R2018b

Conformance Testing

Ensure your designs comply with the supported 3GPP LTE standard releases.

» [Learn more](#)

R2018a

Power Amplifier Characterization with DPD for Reduced Signal

Provides a methodology for characterizing a nonlinear RF Blockset™ power amplifier (PA) with memory and an adaptive DPD.

R2018a

Visualizing RF Budget Analysis Over Bandwidth

Programmatically perform an RF budget analysis of an RF receiver system and visualize computed budget results across the bandwidth.

R2018a

Improve SNR and Capacity of Wireless Communication Using...

The goal of a wireless communication system is to serve as many users with the highest possible data rate given constraints.

[Open Script](#)

R2018a

Introduction to Hybrid Beamforming

Introduces the basic concept of hybrid beamforming and shows how to simulate such a system.

[Open Script](#)

R2018a

Massive MIMO Hybrid Beamforming

How hybrid beamforming is employed at the transmit end of a massive MIMO communications system, using techniques for both

R2018a

SINR Map for a 5G Urban Macro-Cell Test Environment

This example shows how to construct a 5G urban macro-cell test environment and visualize the signal-to-interference-plus-noise

R2018a

Resources – Links in PDF Document

View web resources

[Wireless Communications Design with MATLAB](#)

[MATLAB and Simulink for 5G Technology Development](#)

Read eBook and white papers

[5G Development with MATLAB](#) (eBook)

[Hybrid Beamforming for Massive MIMO Phased Array Systems](#) (white paper)

[Four Steps to Building Smarter RF Systems with MATLAB](#) (white paper)

[Evaluating 5G Waveforms Over 3D Propagation Channels with the 5G Library](#) (white paper)

Download software

[Wireless communications trial package](#)